



**Fitting type:** Undermount or Inset

**Sink handing:** Not handed

**Finish style:** Brushed steel

- **Min. base unit (mm):** 600
- **Packaged size L x W x D:** 595 x 495 x 250mm
- **Supplied boxed or sleeved:** Boxed
- **Boxed weight:** 7.30 kg
- **Sink only weight:** 4.99 kg

- Durable 304 stainless steel construction throughout
- Can be fitted as undermount or inset
- Sleek, stylish and synchronised, allowing for a seamless kitchen workflow.
- Designed to work effortlessly with it's all System Sync accessories
- Smooth lined luxury Orbit waste supplied as standard

**Included parts:**



1 x AX1001 (m)  
90mm (1.5") Orbit manual basket strainer waste - short bolt



1 x AX1102 (m)  
Rectangular overflow (90x30mm vertical)



1 x AX1008 (m)  
1.0 Bowl pipework



2 x AX1017 (m)  
Undermount fixing clips x 4



1 x AX1133 (m)  
Inset clips x 9



1 x AX4048  
Fitting & care instructions & data sheet - st/st inset/undermount

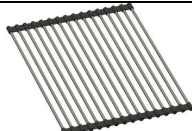

1 x AX2506 (m)  
System Drainer / Trivet (roll up)



1 x AX1508 (m)  
System Colander



1 x AX2024 (m)  
System Bamboo Chopping Board

**Recommended accessories:**



1 x AX1011  
Tap stabilising bracket

All accessories can be purchased directly from [www.abode-shop.co.uk](http://www.abode-shop.co.uk) or phone 01226 283434

**Materials & workmanship warranty summary:**

- Sink materials & workmanship 10 years.
- Waste kits 1 year.
- Connecting pipework 1 year.

**Care instructions summary:**

- Clean the products regularly using soapy water and a non-abrasive cloth, regular cleaning will prevent the build-up of lime scale and dirt.
- Avoid contact with corrosive or abrasive substances.
- After cleaning rinse thoroughly with clean water then dry.
- For more detail see supplied booklet or [www.abodedesigns.co.uk](http://www.abodedesigns.co.uk)

**Product dimensions and installation information:** note:  symbol indicates position of acoustic pad on stainless products.

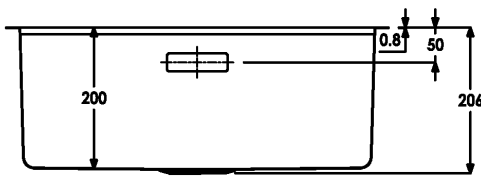
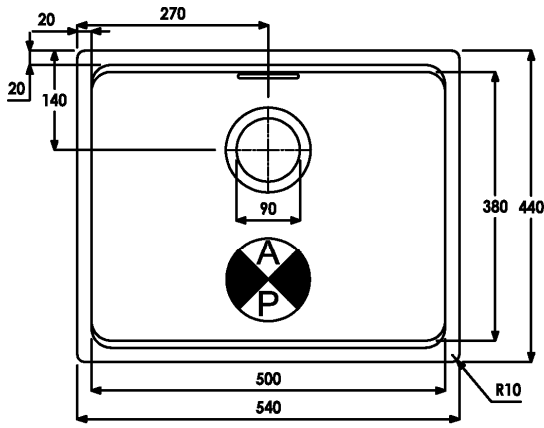

### INSET CUT OUT

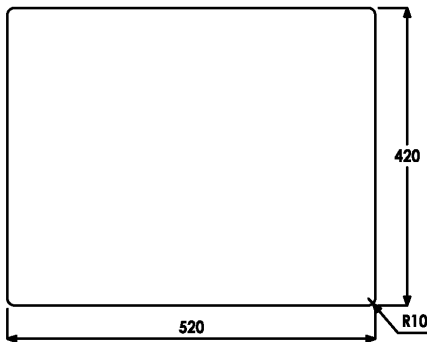

### UNDERMOUNT CUT OUT

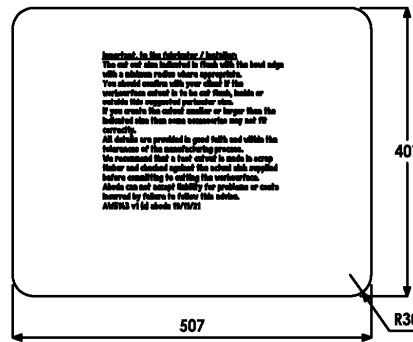

**Additional notes:**

**Overall product size:** 540 x 440 x 206, corner radius 10 mm

**Taphole(s) detail:** None

**Wastehole(s) detail (mm):** 90 / N/A / N/A

**Min. base unit (mm) (refers to space required for bowl, tap and overflow only):** fits 600 carcass

**Min. Recessed fitting width (mm):** required (bowl(s), tap and overflow: 500

**\*Worktop cut out size (mm):** varies x varies, corner radius varies, for .DXF cut files please see our website

**Min. & Max worktop depth or clip depth reach range (mm):** 0 - 43

**Fitting temple supplied?** No, use cut out drawings supplied for fitting type required

**Dishwasher under drainer?** Distance from top of worktop to underside of the drainer n/a mm



**\*Important, fabricator / installer notes for undermount & Flushmount sinks:**

The cut out size indicated is aligned with outside edge of the bowl top radius (similar to the example below).

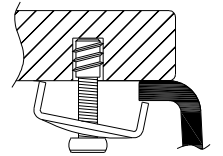

You should confirm with your client if the worksurface cutout is to be cut flush, inside or outside this suggested perimeter shape & size.

If you create the cutout smaller or larger than the indicated size then the fit of the accessories may be affected and should be physically checked.

**General:**

All details are provided in good faith but do not include the tolerances of the material or manufacturing process.

**We request that a test cutout is made in scrap timber and checked against the actual sink to be installed before committing to cutting the final worksurface.**

**Abode can not accept liability for problems or costs incurred by failure to follow this request.**

Note: the dimensions on ceramic fireclay products are subject to wider tolerances due to the nature of this natural material and the firing process.

CAD cutout files can be downloaded from [www.abodedesigns.co.uk](http://www.abodedesigns.co.uk)

**Bowl details:** (sizes in mm unless specified otherwise)

**Bowl 1 (typically main bowl):**

**Bowl 1 size L x W x D (mm):** 500 x 380 x 200

**Bowl 1 construction:** Pressed, 0.80 mm

**Bowl 1 floor radius (mm):** 15

**Bowl 1 Wastehole diameter (mm):** 90

**Bowl 1 overflow:** Rectangular

**Bowl 1 texture:** Brushed stainless

**Bowl 1 apx. volume (litres):** 24.90

**Bowl 2 (typically 1/2 or 3/4 bowl):**

**Bowl 2 size L x W x D (mm):** N/A x N/A x N/A

**Bowl 2 construction:** N/A, N/A mm

**Bowl 2 floor radius (mm):** N/A

**Bowl 2 Wastehole diameter (mm):** N/A

**Bowl 2 overflow:** N/A

**Bowl 2 texture:** N/A

**Bowl 2 apx. volume (litres):** N/A

**Bowl 3:**

**Bowl 3 size L x W x D (mm):** N/A x N/A x N/A

**Bowl 3 construction:** N/A, N/A mm

**Bowl 3 floor radius (mm):** N/A

**Bowl 3 Wastehole diameter (mm):** N/A

**Bowl 3 overflow:** N/A

**Bowl 3 texture:** N/A

**Bowl 3 apx. volume (litres):** N/A

