



Manual for installation,
use and maintenance

MXN070FR
Induction hob

Contents:

- 3 Important information
- 4 Important safety information
- 7 Important safety instructions
- 7 Safety warnings
- 12 Hob layout
- 13 Using your induction hob
- 13 Using the touch controls
- 14 Choosing the right cookware
- 14 Starting to cook
- 16 Locking the controls
- 17 Auto shutdown protection
- 18 Using the timer
- 19 Heat settings
- 20 Care and maintenance
- 23 Troubleshooting
- 25 Installation
- 29 Mains electricity connection
- 31 Technical data

Important

The CDA Group Ltd cannot be held responsible for injuries or losses caused by incorrect use or installation of this product. Please note that CDA reserve the right to invalidate the guarantee supplied with this product following incorrect installation or misuse of the appliance or use in a commercial environment.

This appliance is not designed to be used by people (including children) with reduced physical, sensorial or mental capacity, or who lack experience or knowledge about it, unless they have had supervision or instructions on how to use the appliance by someone who is responsible for their safety.

Under no circumstances should any external covers be removed for servicing or maintenance except by suitably qualified personnel.

Appliance information:

Please enter the details on the appliance rating plate below for reference, to assist CDA Customer Care in the event of a fault with your appliance and to register your appliance for guarantee purposes.

Appliance Model	
Serial Number	

EU Declarations of Conformity

This appliance has been manufactured to the strictest standards and complies with all applicable legislation, including Electrical safety (LVD) 2014/35/EU and Electromagnetic interference compatibility

(EMC) 2014/30/EU. Parts intended to come into contact with food conform to 1935/2004/EC.

IMPORTANT INFORMATION FOR CORRECT DISPOSAL OF THE PRODUCT IN ACCORDANCE WITH EC DIRECTIVE 2012/19/EU.

At the end of its working life, the product must be taken to a special local authority waste collection centre or to a dealer providing appliance recycling services.

Disposing of a household appliance separately avoids possible negative consequences for the environment and health. It also enables the constituent materials to be recovered, saving both energy and resources. As a reminder of the need to dispose of household appliances separately, the product is marked with a crossed-out wheeled dustbin. 

Important safety information

- Never leave the appliance unattended when in use. Boil-over causes smoking and greasy spillovers may ignite.
- Never use your appliance as a work or storage surface.
- Never leave any objects or utensils on the appliance.
- Do not place or leave any magnetisable objects (e.g. credit cards, memory cards) or electronic devices (e.g. computers, MP3 players) near the appliance as they may be affected by its electromagnetic field.
- Never use your appliance for warming or heating the room.
- After use, always turn off the cooking zones and the cooktop as described in this manual (i.e. by using the touch controls). Do not rely on the pan detection feature to turn off the cooking zones

when you remove the pans.

- Do not allow children to play with the appliance nor sit, stand or climb on it.
- Do not leave children alone or unattended in the area where the appliance is in use.
- Children or persons with a disability which limits their ability to use the appliance should have a responsible and competent person to instruct them in its use. The instructor should be satisfied that they can use the appliance without danger to themselves or their surroundings.
- Do not repair or replace any part of the appliance unless specifically recommended in the manual. All other servicing should be done by a qualified technician.
- Do not use a steam cleaner to clean your cooktop.
- Do not place or drop heavy objects on your cooktop.
- Do not stand on your cooktop.
- Do not use pans with jagged edges or drag pans across the induction glass surface as this can scratch the glass.
- Do not use scourers or any other harsh abrasive cleaning agents to clean your cooktop as these can scratch the induction glass.
- This appliance is intended to be used in a household or similar environments such as staff kitchen areas in shops, offices and other residential environments.
- If the supply cord is damaged, it must be replaced by the manufacturer, its service agent or a similarly qualified person in order to avoid a hazard.
- Care should be taken to avoid touching heating elements.
- The appliance is not intended to be operated by means of an external timer or separate remote-control system.

- Children less than 8 years of age should be kept away unless continuously supervised.
- This appliance can be used by children aged 8 and above and persons with reduced physical, sensory or mental capabilities or lack of experience and knowledge, if they have been given supervision or instructions concerning the use of the appliance in a safe way and understand the hazards involved.

WARNING: The appliance and its accessible parts become hot during use.

WARNING: Unattended cooking on the hob with fat or oil can be dangerous and may result in a fire. NEVER try to extinguish such fire with water! Switch off the appliance and then cover the flame with a lid or a fire blanket.

WARNING: Do not store items on the cooking surfaces as this presents a fire hazard.

WARNING: If the surface is cracked, switch off the appliance to avoid the possibility of an electric shock.

CAUTION: The cooking process has to be supervised.



NOTICE: The crystallite glass is still hot after use, please do not touch!

Important instructions

Read these instructions carefully before installing or using this appliance.

- No combustible materials or products should be placed on this

appliance at any time.

- Please make this information available to the person responsible for installing the appliance.
- In order to avoid a hazard, this appliance must be installed according to these instructions for installation.
- This appliance must be installed and earthed only by a suitably qualified person.
- This appliance should be connected to a circuit which incorporates an isolating switch, providing full disconnection from the power supply.

Failure to install the appliance correctly could invalidate any warranty or liability claims.

Safety warnings

Your safety is important to us. Please read this information before using the appliance.

Installation

Electrical Shock Hazard

- Disconnect the appliance from the mains electricity supply before carrying out any work or maintenance on it.
- Connection to a good earth wiring system is essential and mandatory.
- Alterations to the domestic wiring system must only be made by a qualified electrician.
- Failure to follow this advice may result in electrical shock or death.

Cut hazard

- Take care - panel edges are sharp.
- Failure to use caution could result in injury or cuts.

Operation and maintenance

Electrical shock hazard

- Do not cook on a broken or cracked hob. If the hob surface should break or crack, immediately switch off the appliance at the mains power supply (wall switch) and contact a qualified technician.
- Turn off the hob at the wall switch before cleaning or maintenance.
- Failure to follow this advice may result in electrical shock or death.

Health hazard

- This appliance complies with electromagnetic safety standards.
- However, persons with cardiac pacemakers or other electrical implants (such as insulin pumps) must consult with their doctor or implant manufacturer before using this appliance to make sure that their implants will not be affected by the electromagnetic field.
- Failure to follow this advice may result in death.

Hot surface hazard

- During use, the appliance becomes hot. Care should be taken to avoid touching the heating elements.
- Do not let your body, clothing or any item other than suitable cookware contact the induction glass until the surface is cool.
- Metallic objects such as knives, forks, spoons and lids should not be placed on the hob surface since they can get hot.
- Keep children away.

- Handles of saucepans may be hot to touch. Ensure that the saucepan handles do not overhang other cooking zones that are switched on. Make sure children can't reach the cookware handles.
- Failure to follow this advice could result in burns and scalds.

FOR THOSE WITH HEART PACEMAKERS OR ACTIVE IMPLANTS:

The function of this hob conforms to current electromagnetic interference standards and thus is in total compliance with legal requirements (2004/108/CE directives).

To avoid interference between your hob and a pacemaker, your pacemaker must be designed and programmed in compliance with the regulations that apply to it. As such, CDA guarantee only that our product is compliant.

With regard to the compliance of the pacemaker or any potential incompatibility, you should obtain information from the manufacturer or your attending physician.

Cooking on Induction

The principle of induction cooking is based on magnetic effect. When you put your cookware on an induction zone and switch it on, the electronic boards in the hob produce induced currents in the base of the cookware and instantly raise its temperature. This heat is then transferred to the food inside the cookware.

The best cookware to use with induction cooking has thick flat bases, as the heat will be better distributed meaning cooking is more even. Most cookware is compatible with induction cooking.

There are three ways to check the suitability of your cookware:

1. Using a magnet to see if the base of the pan is magnetic: If the magnet sticks, then the cookware is compatible.
2. Place the pan on one of the cooking zones and switch the zone on. If the display continues to show the selected power level then the cookware is compatible. If the display shows “E”, the cookware cannot be used on an induction hob.
3. Check the instructions or packaging of the pans for the symbols indicating suitability for use with induction.

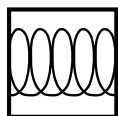

Important

- Do not use the hob if the glass surface is cracked or damaged to prevent the risk of electric shock. Disconnect it from the power supply.
- Ensure that the power cable of a connected electrical appliance near the hob is not in contact with the cooking zones.

Saving energy

Using energy in a responsible way not only saves money but also helps the environment. The following will help you to save energy:

- Use proper pans for cooking. A saucepan should never be smaller than the zone. Always remember to cover any pans.
- Ensure pans and the hob are kept clean. Soils can prevent heat transfer and repeatedly burnt-on spillages can often only be removed by products which cause damage to the environment.
- Do not uncover the pan too often (a watched pot never boils!).

Be sure to recycle all of the packaging.

All packaging materials used are 100% recyclable.

Hob layout

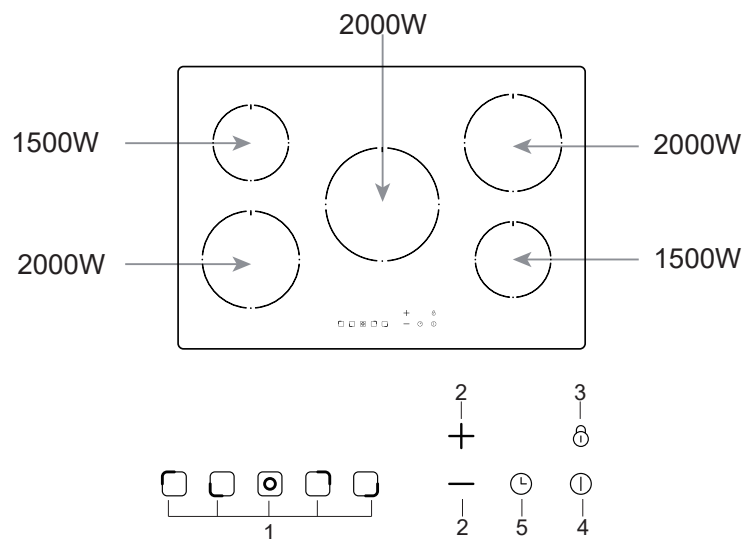

Induction hob

- | | |
|------------------------------------|-------------------|
| 1. Heating zone selection controls | 4. ON/OFF control |
| 2. Power / timer regulating key | 5. Timer control |
| 3. Keylock control | |

POWER LIMIT WORKING MODE:

The left two heating zones can operate on the full power setting. The right two and the middle heating zones if operated simultaneously, exceed 3600W. This means when selecting the higher settings for these zones, they will adjust automatically to make total power less than 3600W.

Auto adjustment rule for right two heating zones and middle heating zone: If you select a higher heat setting for one heating zone, the other heating zone heat setting will lower automatically to make total power less than 3600W.

Using your induction hob

Before using your new hob

- Read this guide, taking special note of the 'Safety Warnings' section.
- Remove any protective film that may still be on your induction hob.

Using the touch controls

- The controls respond to touch so you don't need to apply any pressure.
- Use the ball of your finger, not its tip.
- You will hear a beep each time a touch is registered.
- Make sure the controls are always clean, dry and that there are no objects (e.g. a utensil or a cloth) covering them.
- Even a thin layer of water may make the controls difficult to operate.



Choosing the right cookware

Only use cookware with a base suitable for induction cooking. Look for the induction symbol on the packaging or the bottom of the pan.

- You can check whether your cookware is suitable by carrying out a magnet test. Move a magnet towards the base of the pan. If it is attracted, the pan is suitable for induction.
- If you do not have a magnet:
 1. Put some water in the pan you want to check.
 2. If "H" does not flash in the display and the water is heating, the pan is suitable.
- Cookware made from the following materials is not suitable: pure stainless steel, aluminium or copper without a magnetic base,

glass, wood, porcelain, ceramic and earthenware.

- Do not use cookware with jagged edges or a curved base.
- Make sure that the base of your pan is smooth, sits flat on the glass and is the same size as the cooking zone. Using a pot that is slightly wider means energy will be used at its maximum efficiency. If you use a smaller pot, efficiency could be less than expected. Pots with a diameter of less than 140 mm could be undetected by the hob if placed on the larger cooking zone. Always centre your pan on the cooking zone.
- Always lift pans off the induction hob – do not slide as they may scratch the glass.

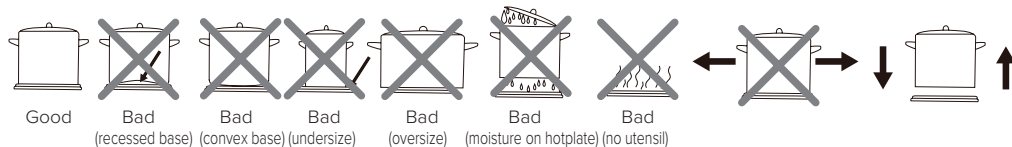

To start cooking

1. Touch the ON/OFF control.

With the power on, the buzzer beeps once, all displays show “ – “ or “ – – “, indicating that the induction hob has entered the standby mode.

2. Place a suitable pan on the cooking zone that you wish to use.

Make sure the bottom of the pan and the surface of the cooking zone are clean and dry.

3. Touch the heating zone selection control and the indicator next to the key will flash.

4. Select a heat setting by touching the “-“ or “+” control. If you don't choose a heat setting within 1 minute,

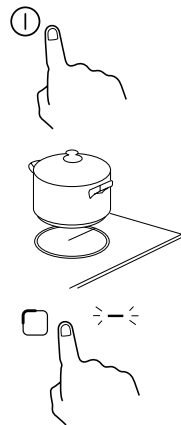

the induction hob will automatically switch off. You will need to start again at step 1.

You can touch the heating zone selection again and modify the heat setting at any time during cooking.

If the display flashes “ E ” alternately with the heat setting, this means means that:

- You have not placed a pan on the correct cooking zone or,
- The pan you're using is not suitable for induction cooking or,
- The pan is too small or not properly centred on the cooking zone.

No heating takes place unless there is a suitable pan on the cooking zone. The display will automatically turn off after 1 minute if no suitable pan is placed on it.

When you have finished cooking

1. Touch the heating zone selection control that you wish to switch off.
2. Turn the cooking zone off by scrolling down to “0”. Make sure the display shows “0” and then “H”.
3. Turn the hob off by touching the ON/OFF control.
4. Beware of hot surfaces indicator “H” will show which cooking zone is hot to touch. It will disappear when the surface has cooled down to a safe temperature. It can also be used as an energy saving function - if you want to heat further pans, use the hotplate that is still hot.

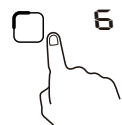

Locking the controls

- You can lock the controls to prevent unintended use (for example children accidentally turning the cooking zones on).
- When the controls are locked, all the controls except the ON/OFF control are disabled.

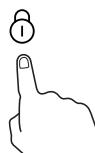

To lock the controls:

- Touch the lock key. The timer indicator will show “Lo”.

To unlock the controls:

1. Make sure the induction hob is turned on.
2. Touch and hold the lock key for a while.
3. You can now start using your induction hob.

When the hob is in lock mode, all controls are disabled, except the ON/OFF. You can always turn the induction hob off with the ON/OFF control in an emergency, but you would have to unlock the hob first in the next operation.

Overheating protection

The appliance is equipped with a temperature sensor which can monitor the temperature inside the induction hob. When an excessive temperature is monitored, the induction hob will stop operation automatically.

Detection of small articles

When an unsuitably sized or non-magnetic pan (e.g. aluminium), or some other small item (e.g. knife, fork, key) has been left on the hob, the display flashes “” and the hob will automatically go into standby mode in 1 minute. The fan will keep cooling down the induction hob for a further 2 minutes.

Auto shutdown protection

Auto shutdown is a safety protection function for your induction hob. It will automatically turn off after a certain period of time. The default working times for various power levels are shown in the below table:

Power level	1	2	3	4	5	6	7	8	9
Default working time (hour)	8	8	8	4	4	4	2	2	2

When a pot is removed, the induction hob can stop heating immediately and automatically switch off after 1 minute.



People with a heart pacemaker should consult their doctor before using this unit.

Using the timer

- You can set it to turn one cooking zone off after the set time is up.
- You can set the timer up to 99 minutes.

Setting the timer to turn off one cooking zone

- Touch the heating zone selection control that you want to set the timer for.
- Touch timer control, the minder indicator will start flashing and “30” will show in the timer display.
- Set the time by touching the “+” and “-” buttons.
Hint: Touch the “-“ or “+” control of the timer once, the time will decrease or increase by 1 minute.
- Touch the “-” control to reduce the time outstanding to zero or press the “timer control” when the “00” shows in the minute display to cancel the timer.
- When the time is set, it will begin to count down immediately. The display will show the remaining time and the timer indicator will flash for 5 seconds.
- When cooking timer expires, the corresponding cooking zone will switch off automatically.

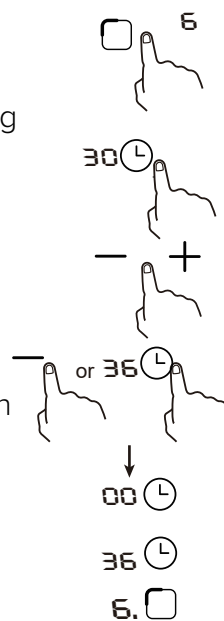

Other cooking zones will keep operating if they have been turned on previously.

NOTE: The red dot next to power level indicator will illuminate, indicating that zone is selected.

NOTE: Timer display will show the shortest set time of the selected zones, and that cooking zone with the shortest set time will be with the red dot flashes.

Cooking guidelines



Take care when frying as the oil and fat heat up very quickly. At extremely high temperatures oil and fat will ignite spontaneously and this presents a serious fire risk.

Heat settings

The settings below are guidelines only. The exact setting will depend on several factors, including your cookware and the amount you are cooking. Experiment with the induction hob to find the settings that best suit you.

Heat setting	Suitability
1-2	<ul style="list-style-type: none"> Delicate warming for small amounts of food Melting chocolate, butter and foods that burn quickly Gentle simmering Slow warming
3-4	<ul style="list-style-type: none"> Reheating Rapid simmering Cooking rice
5-6	<ul style="list-style-type: none"> Pancakes
7-8	<ul style="list-style-type: none"> Cooking pasta
9	<ul style="list-style-type: none"> Stir-frying Searing Bringing soup to the boil Boiling water

Care and maintenance

Always disconnect the appliance from the power supply before undertaking any cleaning or maintenance.

Everyday soiling on glass (fingerprints, marks, stains left by food or non-sugary spillovers on the glass)

1. Switch off the power to the hob.
2. Apply a hob cleaner while the glass is still warm (but not hot).
3. Rinse and wipe dry with a clean cloth or paper towel.
4. Switch the power to the hob back on.

When the power to the hob is switched off, there will be no hot surface indication but the cooking zones may still be hot! Take extreme care. Heavy-duty or some nylon scourers and harsh/abrasive cleaning agents may scratch the glass surface, so please do check that they are suitable for induction hob care before use. Never leave cleaning residue on the hob, the glass may become stained.

Boil-overs, melts and hot sugary spills on the glass

Remove these immediately with a palette knife or razor blade scraper suitable for induction hobs but beware of hot cooking zone surfaces:

1. Switch off the power to the hob via the isolation switch.
2. Hold the blade or utensil at a 30° angle and scrape the soiling or spill to a cool area of the hob.
3. Clean up the soiling or spill with a dish cloth or paper towel.
4. Follow steps 2 to 4 for everyday soiling on glass above.

Remove stains left by melts and sugary food or spillovers as soon as possible. If left to cool on the glass, they may be difficult to remove or even permanently damage the glass surface.

Spillovers on the touch controls

1. Switch off the power to the hob.
2. Soak up the spill.
3. Wipe the touch control area with a clean damp sponge or cloth.
4. Wipe the area completely dry with a paper towel.
5. Switch the power to the hob back on.

The hob may beep and turn itself off, and the touch controls may not function while there is liquid on them. Make sure you wipe the touch control area dry before turning the hob back on.

Hints and tips

1. The induction hob cannot be turned on.
Make sure the induction hob is connected to the power supply and that it is switched on.
Check whether there is a power outage in your home or local area. If you've checked everything and the problem persists, call a qualified technician.
2. The touch controls are unresponsive.
The controls are locked: Unlock the controls. See section "Using Your Induction Hob" for instructions.
3. The touch controls are difficult to operate.
There may be a slight film of water over the controls or you may be using the tip of your finger when touching the controls: Make sure the touch control area is dry and use the ball of your finger when touching the controls.
4. The glass is being scratched.
Tough-edged cookware; unsuitable, abrasive scourer or cleaning products being used: Use cookware with flat and smooth bases. See "Choosing the Right Cookware" and "Care and Cleaning" for further advice.

5. Some pans make crackling or clicking noises.
This may be caused by the construction of your cookware (layers of different metals vibrating differently): This is normal, the noise should quieten down or disappear completely.
6. The induction hob makes a low humming noise when used on a high heat setting.
This is caused by the technology of induction cooking: This is normal, the noise should quieten down or disappear completely when you decrease the heat setting.
7. Fan noise coming from the induction hob.
A cooling fan built into your induction hob has come on to prevent the electronics from overheating. It may continue to run even after you've turned the induction hob off: This is normal and needs no action. Do not switch the power to the induction hob off at the wall while the fan is running.
8. Pans do not become hot and “” appears in the display.
The induction hob cannot detect the pan because it is not suitable for induction cooking. The induction hob cannot detect the pan because it is too small for the cooking zone or not properly centred on it: Use cookware suitable for induction cooking. See section “Choosing the Right Cookware”. Centre the pan and make sure that its base matches the size of the cooking zone.
9. The induction hob or a cooking zone has turned itself off unexpectedly, a tone sounds and an error code is displayed (typically alternating with one or two digits in the cooking timer display).
Technical fault: Please note down the error letters and numbers, switch the power to the induction hob off at the wall, and contact a qualified technician.

Troubleshooting

If an abnormality comes up, the induction hob will automatically enter the protective state and display corresponding protective codes.

The above are the judgment and inspection of common failures. Please do not disassemble the unit by yourself to avoid any danger or damage to the induction hob.

Problem	Possible causes	Possible remedy
The appliance does not work	Break in power supply	Please check the main power is normal; if the leakage protection switch is off; if there is a blown fuse, replace it with a new one; if the main power is normal, check if the plug is connect with socket appropriately; If the hob is wire connection type, disconnect the power, check if the wire is loose; disconnect the power, check if main plug is off; Exclude above reasons, should be appliance fault, send it to service center for repairing
During heating, the unit stops working	Delay off timer activates	Please check if set delay off function. If set delay off function, the unit will stop once delay off time out.
	No pan or pan unsuitable	No pan, please put proper pan. PCB synchronization or drive circuit fault, please send the appliance to service center for repairing.
E2	Input power too low	Low voltage, voltage of the main power is less 180V. Please check if voltage of the main power is normal. Once voltage of the main power returns normal, re-start the unit. Voltage of PCB fault, please send the unit to service center for repairing.
E1	Input power too high	High voltage, voltage of the main power exceeds 250V. Please check if voltage of the main power is normal. Once voltage of the main power returns normal, re-start the unit. Voltage of PCB fault, please send the unit to service center for repairing.
F3	Thermistor of coil short circuit	Sensor of coil thermistor connection error. Or detection part of PCB coil thermistor failure, send to service center for repairing.
F4	Thermistor of coil open circuit	

Problem	Possible causes	Possible remedy
E5	Too high temperature of IGBT thermistor	Too high temperature of IGBT thermistor, air outlet is blocked. Open air outlet, re-start the unit. If still unsolved, it is possible that cooling fan connection error, cooling fan damaged, or drive circuit of fan failure, send to service center for repairing. IGBT temperature sensor open circuit /short circuit. Temperature detection part of PCB IGBT failure, send to service center for repairing.
E3	Too high temperature of coil thermistor	Too high temperature on induction glass surface, please check if there is no water in pan. After treatment, connect with power again. If still unsolved, it is possible that sensor of cooktop failure, send to service center for repairing.
F9	IGBT thermistor short circuit	Sensor of IGBT thermistor connection error. Or detection part of IGBT PCB sensor failure, send to service center for repairing.
FA	IGBT thermistor open circuit	

In the event of a fault with the hob please advise CDA Customer Care.

Contact CDA Customer Care

A: Customer Care Department, The CDA Group Ltd, Harby Road,
Langar, Nottinghamshire, NG13 9HY

T: 01949 862 012

F: 01949 862 003

E: customer.care@cda.co.uk

W: www.cda.co.uk

Installation information

Selection of Installation Equipment

Cut out the work surface according to the sizes shown in the drawing. Ensure the thickness of the work surface is at least 20mm. Please select a heat-resistant work surface material to avoid deformation caused by the heat radiation from the hotplate.

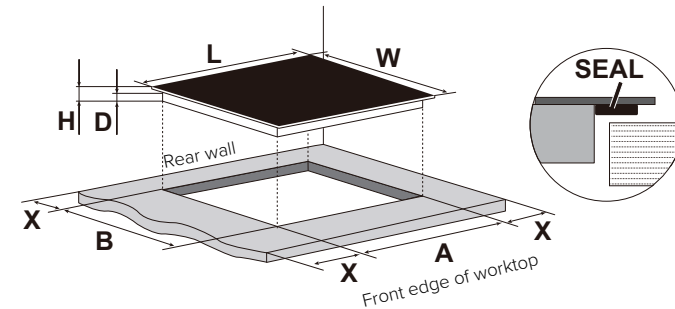

L (mm)	W (mm)	H (mm)	D (mm)	A (mm)	B (mm)	X (mm)
750	520	62	56	730	490	50 min

The hob has a special seal which prevents liquid from entering the cabinet. Follow these instructions in order to correctly apply this seal.

- Detach the seals from their backing.
- Turn the hob over and correctly position the seal under the edge of the hob so that the outer part of the seal perfectly matches the outer edge of the hob.
- Fix the seal to the hob evenly and securely, pressing it firmly in place.



Note: The distance between the hotplate and the cupboard above should be at least 600mm.

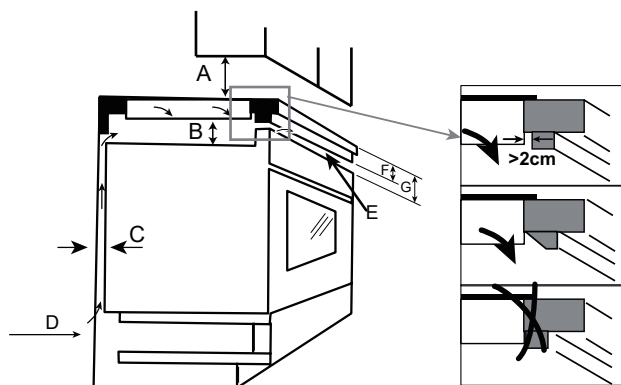

Note: There must be a 560x5mm opening in the front (position E) to dissipate the air.

A (mm)	B (mm)	C (mm)	D	E	F	G
600	10 min*	20 min	Air intake	Air exit $\geq 5\text{mm}$	$>35\text{mm}$	$<50\text{mm}$

* When installing the hob above working drawers this requirement does not apply



After installation, ensure the airflow opening is not blocked by the worktop.

Before you install the hob, make sure that:

- The work surface is square and level, and that no structural units interfere with the space requirements.
- The work surface is made of a heat-resistant material.
- If the hob is installed above an oven, the oven has a built-in cooling fan.

- The installation will comply with all clearance requirements and applicable standards and regulations.
- A suitable isolating switch providing full disconnection from the mains power supply is incorporated in the permanent wiring, mounted and positioned to comply with the local wiring rules and regulations.
- The isolating switch must be of an approved type and provide a 3 mm air gap contact separation in all poles (or in all active [phase] conductors if the local wiring rules allow for this variation of the requirements).
- The isolating switch will be easily accessible after installation.
- You consult local building authorities and by-laws if in doubt regarding installation.
- You use heat-resistant materials (such as ceramic tiles) for the wall surfaces surrounding the hob.

When you have installed the hob, make sure that:

- The power supply cable is not accessible through cupboard doors or drawers.
- There is adequate flow of fresh air from outside the cabinets to the base of the hob.
- If the hob is installed above a drawer or cupboard space, the hob bottom temperature may be too high, in order to prevent hand or other flammable/combustion contact, a thermal protection barrier is installed below the base of the hob.
- The isolating switch is easily accessible.

Before locating the fixing brackets

The unit should be placed on a stable, smooth surface to prevent damage. Do not apply force onto the controls protruding from the hob.

Adjusting the bracket position

Attach the four supplied fixing clips to the sides of the hob (see picture) Make sure that the worktop is clean and dust free and insert the hob into the cut-out opening. Press the hob firmly into place so that the seal connects with the worktop.

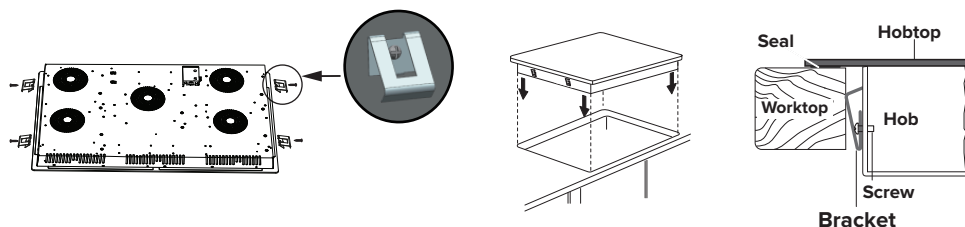

Caution!

- The induction hot must be installed by qualified personnel or technicians.
- The hob must not be installed directly above a dishwasher, fridge, freezer, washing machine or a dryer as the humidity may damage the hob electronics.
- The induction hot must be installed in a way that better heat radiation can be ensured to enhance its reliability.
- The wall and induced heating zone above the worksurface must withstand heat generated by the hob.
- To avoid any damage, the sandwich layer and adhesive must be resistant to heat.



Mains electricity connection

Warning! This appliance must be earthed.

The appliance must be connected by qualified electrician, who is a member of the N.I.C.E.I.C. and who will comply with the I.E.T. and local regulations. When installing this product we recommend you seek the help of another individual.

Before connecting the downdraft induction hob to the mains power supply, check that:

- The domestic wiring system is suitable for the power drawn by the downdraft induction hob.
- The voltage corresponds to the value given on the rating plate.
- The power supply cable sections can withstand the load specified on the rating plate.
- To connect the hob to the mains power supply, do not use adapters, reducers, or branching devices, as they can cause overheating and fire.
- The power supply cable must not touch any hot parts and must be positioned so that its temperature will not exceed 75°C at any point
- Check with an electrician whether the domestic wiring system is suitable without alterations. Any alterations must only be made by a qualified electrician.
- The power supply should be connected in compliance with the relevant standard, the method of connection is shown on page 30.

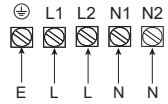
<p>Caution! Voltage of heating elements 220-240V</p> <p>Caution! In the event of any connection the safety wire must be connected to the  E terminal.</p>		<p>Recommended type of connection lead</p>
<p>-For 220 - 240 V earthed one-phase connection.</p> <p>-Phases in succession L1, L2, Neutral to N1,N2.</p> <p>-Protective ground to </p>		

- If the cable is damaged or to be replaced, the operation must be carried out by a service agent or a suitably qualified professional.
- The appliance for disconnection from the supply mains having a contact separation in all poles providing full disconnection under overvoltage category III conditions should be provided in fixed wiring in accordance with the wiring rules.
- The installer must ensure that the correct electrical connection has been made and that it is compliant with all applicable standards and safety regulations.
- The cable must not be bent or compressed.
- The cable must be checked regularly and replaced by authorised technicians only.

Technical data

Model		MXN070FR
Power supply		AC 220-240V 50Hz
Power	Heating area front left (180mm)	2000W
	Heating area rear left (140mm)	1500W
	Heating area middle (210mm)	2000W
	Heating area rear right (180mm)	2000W
	Heating area front right (140mm)	1500W
Size (mm)		750x520x62
Built-in size (mm)		730x490

The Manufacturer hereby declares that this product complies with the general requirements pursuant to the following European Directives and analogous UK requirements:

- The Low Voltage Directive 2014/35/EC / Electrical Equipment (Safety) Regulations 2016
- Electromagnetic Compatibility Directive 2014/30/EC / Electromagnetic Compatibility Regulations 2016
- ErP Directive 2009/125/EC / The Ecodesign for Energy-related Products Regulations 2010 (as amended) for the applicable implementing measures which apply in Great Britain and Northern Ireland, respectively

The product has been marked with  symbols and the Declaration of Conformity, the Manufacturer has drawn up the declaration and is available to the competent authorities regulating the market.



Serviced by



For service or queries relating to your product please contact:

The Customer Care Department on **01949 862 012** or email customer.care@cda.co.uk

For more information please contact:

The Sales Department on **01949 862 010** or email sales@cda.co.uk

Customer Care Department. The CDA Group Ltd, Harby Road, Langar, Nottinghamshire, NG13 9HY
T: 01949 862 012 **F:** 01949 862 003 **E:** customer.care@cda.co.uk