

# Stainless Steel Inset / Undermount Sink

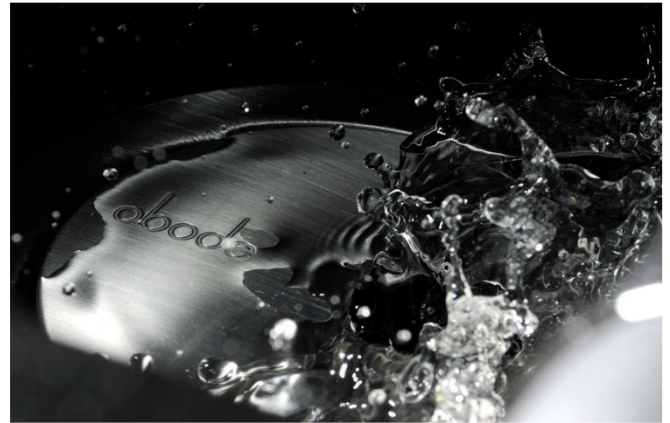

## 10 Year Warranty Terms and Conditions

In the unlikely event that you should experience any defect in the materials or workmanship of your new Abode sink within 10 years of purchase, the manufacturer will repair or replace all or any part of the product that is defective, at their discretion. The manufacturer will not be responsible for any other consequential costs such as labour, removal or reinstallation of the sink or any other connected or related products.

This is provided that the product has been used for normal domestic purposes in the UK & Eire, and that the care, installation and maintenance instructions have been observed. The warranty extends to the original purchaser only. You should retain a copy of your dated invoice as proof of purchase to validate any claims under this guarantee.

Please note that this product is manufactured using natural materials so slight shade variations can occur. Marks, scuffs and scratches caused during installation or accidental damage are not covered by this guarantee.

## Care Instructions for your Kitchen Sink

**To maintain the appearance of this product, ensure that it is regularly cleaned using only a clean, soft damp cloth. A solution of warm water and a mild liquid non-antibacterial detergent may be used where necessary, and then the product rinsed thoroughly and wiped dry. Any other cleaning action will invalidate your warranty.**

No household or industrial chemicals should come into contact with this product to prevent damage.

No metallic objects should be left in contact with this sink as they may cause corrosion by close contact. Prolonged exposure to acidic or alcoholic drinks or foodstuffs may also cause corrosion.

Do not cut, slice or chop directly onto the sink as this mark the surface finish. Avoid the use of plastic washing up bowls, engrained grit on the bowl underside may mark the surface finish. Avoid impacting the product with sharp or heavy objects such as knives, pans or cooking pots and also avoid contact with abrasives.

For further care and maintenance advice on removing stubborn marks and more examples of objects or actions likely to artificially shorten the life of this product, please visit our website.

Neither are stains, discolouration or corrosion or any damage or defect caused by incorrect installation or abuse of the product.

We are continuously improving and developing our range of products, finishes & colours. Therefore, in the event of a valid claim, we may not be able to provide an identical replacement for the defective product throughout the guarantee period. Where an identical product is no longer available, we will supply the nearest equivalent from our then current product range. In assessing your claim, we must be given the opportunity to inspect the product as installed prior to removal. Any product returned to us must be securely packaged and adequately insured. We will not accept responsibility for any damage caused during transportation.

No installer, dealer, agent or employee of Abode has the authority to modify the obligations or limitations of this warranty. This warranty does not affect your statutory rights.

## Parts and Contents

Key	Description	Qty
A	Sink (may differ from model shown)	1
B	Overflow, waste(s) and pipework	See included specification sheet
C	Care instructions and cut-out sizes	1
D	Inset fixing clips & Undermount brackets, bolts and inserts	See included specification sheet

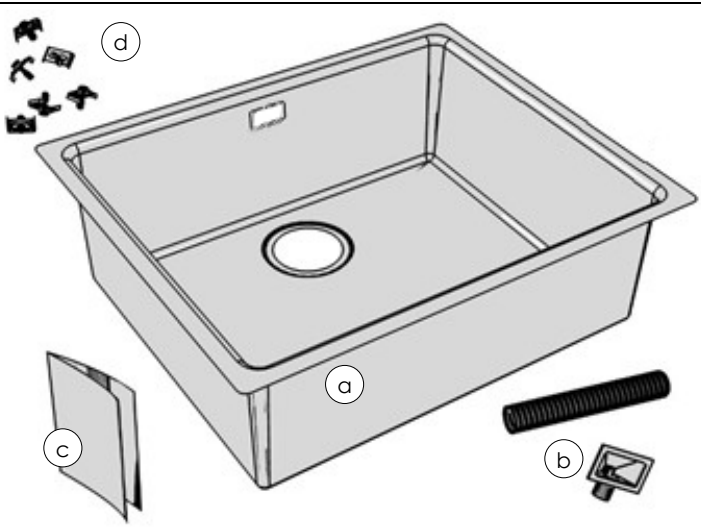

## Installation Instructions

### Preparation

1. Take great care when handling this sink. Whilst every effort has been taken to remove sharp edges, the material by nature may be sharp. We recommend wearing gloves accordingly. Do not lift the product by the waste hole(s) or tap hole(s).
2. Check the package for completeness, possible defects or any transport damage before installation commences. Installed faulty product will not be honoured by the warranty.
3. Check that the supporting carcasses and worktop is level left to right and front to back to ensure the correct drainage of water.
4. Check that the surrounding furniture is the correct size and shape to accept this product and that no plumbing or wiring may foul the installation.
  - a. We recommend that all undermount products should be supported under the reverse face with a substantial braced shelf similar to the example below (when full the sink could weigh up to 50kg). The shelf should allow for small adjustments in height at each corner and so that it could be disassembled from the underside in the event that the sink is accidentally damaged.
  - b. The height of the shelf should be such that when the sink is placed on the shelf the top face rim of the sink is level with the underside face of the worktop, see the example below.

Key	Description
A	Surrounding cupboards or end panels
B	Hole for waste connections (min. recommended dia. 150mm for each waste, centred to waste position)
C	Supporting shelf (moisture resistant timber or similar, ensure framework sits directly under the product)
D	Incoming hot and cold supply pipes
E	Supporting uprights (front & back)

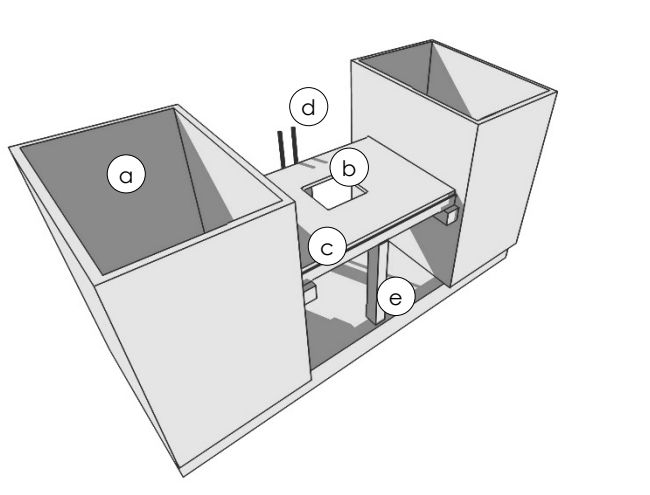

5. If replacing an existing sink, remove this product and clean the surrounding area, ensure the new sink will suit the existing cut-out size and position, otherwise amend the cut-out size accordingly.
6. Collect the tools you will need to complete this installation.

## Undermount Installation:

- Before creating the cut-out in the worktop carefully plan the positioning of the sink. Ensure that the position of the bowl(s), tap and overflows will not interfere with surrounding units or appliances. The cut-out details are published on the included specification sheet and are downloadable as CAD file at [www.abode.eu](http://www.abode.eu) to ensure perfect positioning of this product. Check that the fixing clips will not foul carcass walls or supporting braces.
- Carefully mark out the cut-out using the provided cut-out drawing or template. Create the sink cut-out in the worktop using a router or CNC cutter, follow the manufacturers instructions and take care not to chip, crack or scratch the worktop. If preparing the cut-out in situ cover any open pipework to avoid any debris contaminating the water supply feeds.

**IMPORTANT:** Due to the hand finished dimensional tolerances of our products we strongly recommend making the cut-out in a scrap piece of material then offering it against the actual sink to be fitted. The cut-out size should be adjusted to suit the sink tolerances and retested against the intended product before committing to cutting the final worksurface. **The 'nominal' suggested cut-out size will align the cut-out edge with the bowl edge outer radius**, the offset from the bowl can be adjusted to overhang or be set back according to personal taste but this may interfere with installation or the correct usage of sink accessories.

- When creating the cut-out aperture you should also create a series of holes in the reverse face of the worktop to accept the undermount bracket inserts. The holes should be sized and positioned away from the edge of the sink as shown in Fig 1. All brackets supplied should be used and spaced equally around the perimeter. Where the sink has long and short sides more brackets should be used on the longer sides.  
Note: Suggested  $\varnothing'A' = 8\text{mm}$  (wood or similar) else  $\varnothing'A' = 10\text{mm}$

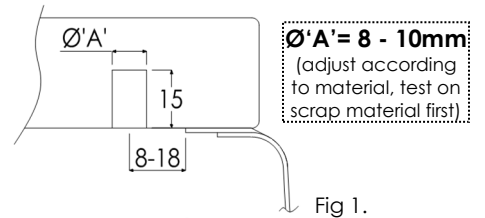

Fig 1.

- Fill the reverse face bracket holes with 2 part epoxy adhesive. Push (non wooden worktops) or screw (wooden worktops) the inserts fully into the holes, let the adhesive cure before any further assembly.  
Note: If screwing in the inserts; use the bolt inside the insert to help drive the insert in, as shown in fig 2. Unscrew the bolt once the insert is securely in the hole leaving the insert behind.

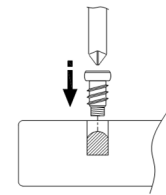

Fig 2.

- Clean the outside rim of the sink and the worktop underside to remove any dirt or grease, allow to dry. Apply a continuous generous bead of good quality silicone onto the rim around the upper perimeter of the sink as shown in fig 3.

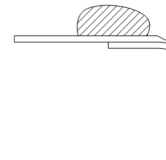

Fig 3.

- Place the sink down squarely onto the rear face of the worktop and flush to the cut-out edge. Using the 'U' shaped brackets and bolts loosely clamp the sink to the worktop underside as shown in fig 4. Tighten the brackets in an order similar to that shown in fig 5. From the top face of the worktop check that the sink position is aligned to the cut-out before tightening the 'U' brackets down fully.

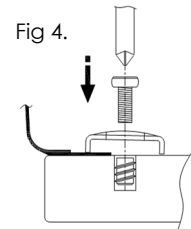

Fig 4.

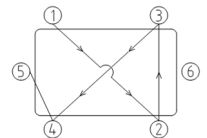

Fig 5.

- Install the tap to the worktop according to the manufacturer's instructions. Ensure the tap is secure as later access may be obstructed by the sink or plumbing. We recommend long flexible tap connectors to help future maintenance.
- Install the basket strainer waste kit(s) and overflow(s) according to the manufacturer's instructions.
- Place the worktop, sink and tap carefully onto the kitchen carcasses. Where possible apply a 2<sup>nd</sup> bead of silicone around inside of the sink and worktop joint as shown in Fig. 6. Any excess silicone can be cleaned away using a proprietary silicone cleaner. Allow the silicone to dry.

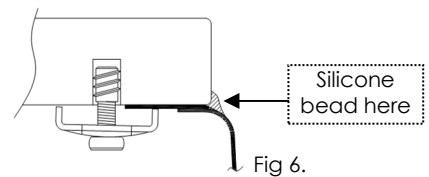

Fig 6.

- Adjusting the supporting shelf at the corners to ensure the weight of the sink is supported but that it does not exert pressure on the worktop causing it to flex or bow upwards.
- Attach the sink connecting pipework to the waste kit(s) according to the manufacturer's instructions.

## Inset Installation:

1. Before creating the cut out in the worktop, carefully plan the positioning of the sink. Ensure that the position of the bowl(s), tap and overflows will not interfere with surrounding units or appliances. The cut out details are published on the included specification sheet and on [www.abode.eu](http://www.abode.eu) to ensure perfect positioning of this product. Check that the fixing clips will not foul carcass walls or supporting braces.
2. Carefully mark out the cut out using the cut out drawing provided. Create the sink cut out in the worktop using a router or jigsaw following the manufacturer's instructions take care not to chip, crack or scratch the worktop. When preparing the cut out cover any open pipework to avoid any debris contaminating the water supply feeds.
3. Seal the cut edges of the worktop with a waterproof sealant to prevent any possible water damage to the worktop. Ensure all exposed cuts on the worktop are correctly sealed.
4. Install the tap to the sink according to the manufacturer's instructions.
5. If required install the tap hole blanking plug. If needed this will be supplied in the fixing kit pack.
6. Install the basket strainer waste kit(s) according to the manufacturer's instructions.
7. Install the overflow(s) according to the manufacturer's instructions. Note depending on the thickness of your worktop you may need to notch out part depth section of the worktop around the overflow, test fit and adjust the cut out now before adding silicone.
8. Add a thin continuous bead of silicone sealant around the underside of the sink rim, ensure to cover the full perimeter of the sink. Roughly centre the sink to the cut out now. Do not use too much silicone as this will make it harder to pull the sink fully flat.

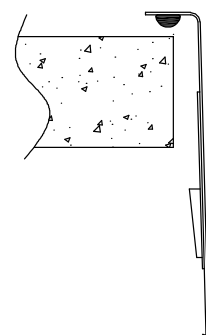

Fig 1.

9. Turn the bolt on the inset clips until the serrated cup is nearest to its own "L" shaped hook, Hang the all the inset bolt clips into the top hook of the sink clip hooks, space all the clips supplied evenly around the perimeter. Once done **very loosely** tighten the clips so they are close to the underside of the worktop. Now double check the sink is still central to the cut-out hole and is straight to the worktop edge.

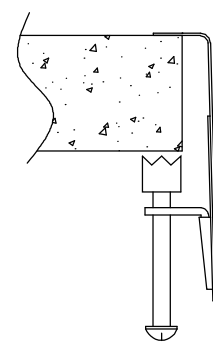

Fig 2.

10. Progressively tighten the inset clip bolts in a staggered clockwise order similar to fig. 3 to ensure the sink does not skew or rotate whilst it is fixed.

**Do not use an electric screwdriver**, this will over tighten the screws and could damage the clips or skew the rotation of the sink. Only use a manual screw driver.

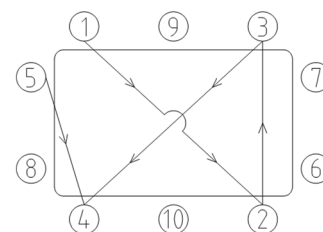

Fig 3.

11. Attach the sink connecting pipework to the waste kit(s) according to the manufacturer's instructions.
12. You may choose to neatly seal around the sink outer perimeter using silicone. Whilst the initial silicone seal bead should provide a watertight seal we recommend this step out of prudence.

## After installation

1. If the sink has a protective plastic film coating this should be removed now, clean the sink using the attached care advice ready for use.
2. Check the sink is flat to the worktop, straight and level; pour a small amount of water onto the drainer to check for drainage.
3. Close the plug(s) in all bowls fill the sink with water below the overflow, check the water does not leak through or around the waste(s).
4. Close the plug(s) in all bowls fill the sink with water above the overflow, check the water exits though the overflow and does not leak from the overflow system.
5. Open the plug(s) and let water drain from the bowls, check the connecting pipework does not leak.
6. We recommend once fully set, the silicone seal should be checked for water tightness and rechecked periodically. If the sink is not to be used for a period after installation, cover the sink and tap to protect them from accidental damage during further surrounding installation work.

## Important Technical Data

Whilst every effort has been made to make these instructions comprehensive, they may not be exhaustive, and we strongly recommend that this product is installed by a skilled professional. This will ensure the best possible finished installation.

This product is made from 304 grade '18/10' stainless steel for the greatest possible durability, after the end of the lifecycle of this product it should be recycled responsibly.

Earth bonding: under current IEE regulations there is no statutory requirement to earth bond sinks as most new wiring installations are protected with an RCD. If you are unsure whether your wiring is protected by an RCD, contact a qualified electrician.

Maximum temperature 300°C\* Note: If this temperature is exceeded, even for short periods, damage to the finish can result.

Waste disposers should be mounted in such a way that the weight of the unit is supported by the kitchen cabinet carcass, not just the sink. Faulty or damaged waste disposal units can cause vibration – this will damage the sink and can loosen connecting pipework or fixings causing water leaks.

All Abode products are designed in accordance with recognised European or global standards. Please ensure that your Abode product is fitted in accordance with localised legislation.

The installation should be periodically checked for damage to water sealing parts as described in the instructions to avoid accidental water damage.

Abode is a registered trademark of Abode. All errors and omissions excepted.

A full technical specification, Declaration of performance (DoP) and copies of these instructions are available for this product on our website. Please see [www.abodedesigns.co.uk](http://www.abodedesigns.co.uk)



**CAUTION:** this product and its components can contain sharp edges, you must handle the product using suitable protective gloves during its installation.

## Manufacturers Product Reference



Norcros Group (Holdings) Ltd.  
T/A Abode  
Ladyfield House, SK9 1BU, UK  
[www.abodedesigns.co.uk](http://www.abodedesigns.co.uk)

Production year: See product label

"Abode DoP"

Product code: See product label

Preparation of food, washing of dishes and discharge of domestic wastewater.

EN 13310

CA - DA

©Abode  
AX4048 v1 11/2021

**Please retain these instructions with the sink for future reference**

abode

Unit L, Zenith Park, Whaley Road, Barnsley, S75 1HT, Tel: 01226 283434 Fax: 01226 282434  
[www.abodedesigns.co.uk](http://www.abodedesigns.co.uk), All errors and omissions excepted.